



RCM-CQC™ 2-Gang Mounting Solution for Cisco Quad Camera

INCLUDED PART LIST

- No. 1** Camera Plate, 813-1109 (Qty 1)
- No. 2** RCM Wall Plate, 813-1109 (Qty 1)
- No. 3** 6-32x1/2", Slotted Screw, White, 860-0014 (Qty 4)
- No. 4** 6-32x3/8", Pan Head Torx Screw, 860-0031 (Qty 2)

PARTS NOT INCLUDED

- No. 5** 2-Gang Electrical Box (Qty 1)
- No. 6** Cisco Quad Camera (Qty 1)

ASSEMBLY INSTRUCTIONS

STEP 1: Attach RCM Wall Plate (No. 2, Qty 1) to 2-gang electrical box (No. 5, Qty 1) using 6-32x1/2" white slotted screws (No. 3, Qty 4).

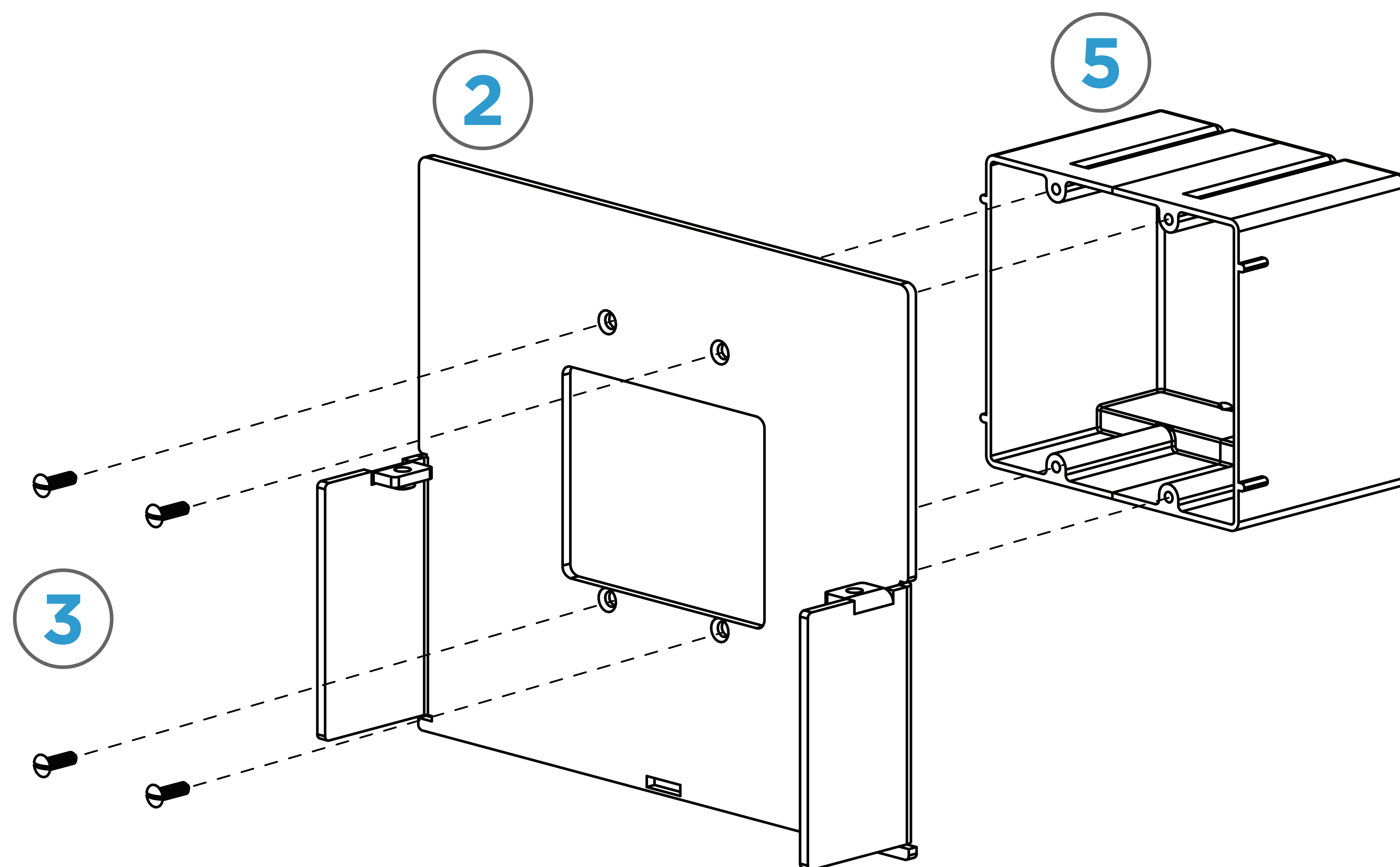

STEP 2: Attach Camera Plate (No. 1, Qty 1) to RCM Wall Plate using 6-32x3/8" pan head Torx screws (No. 4, Qty 2).

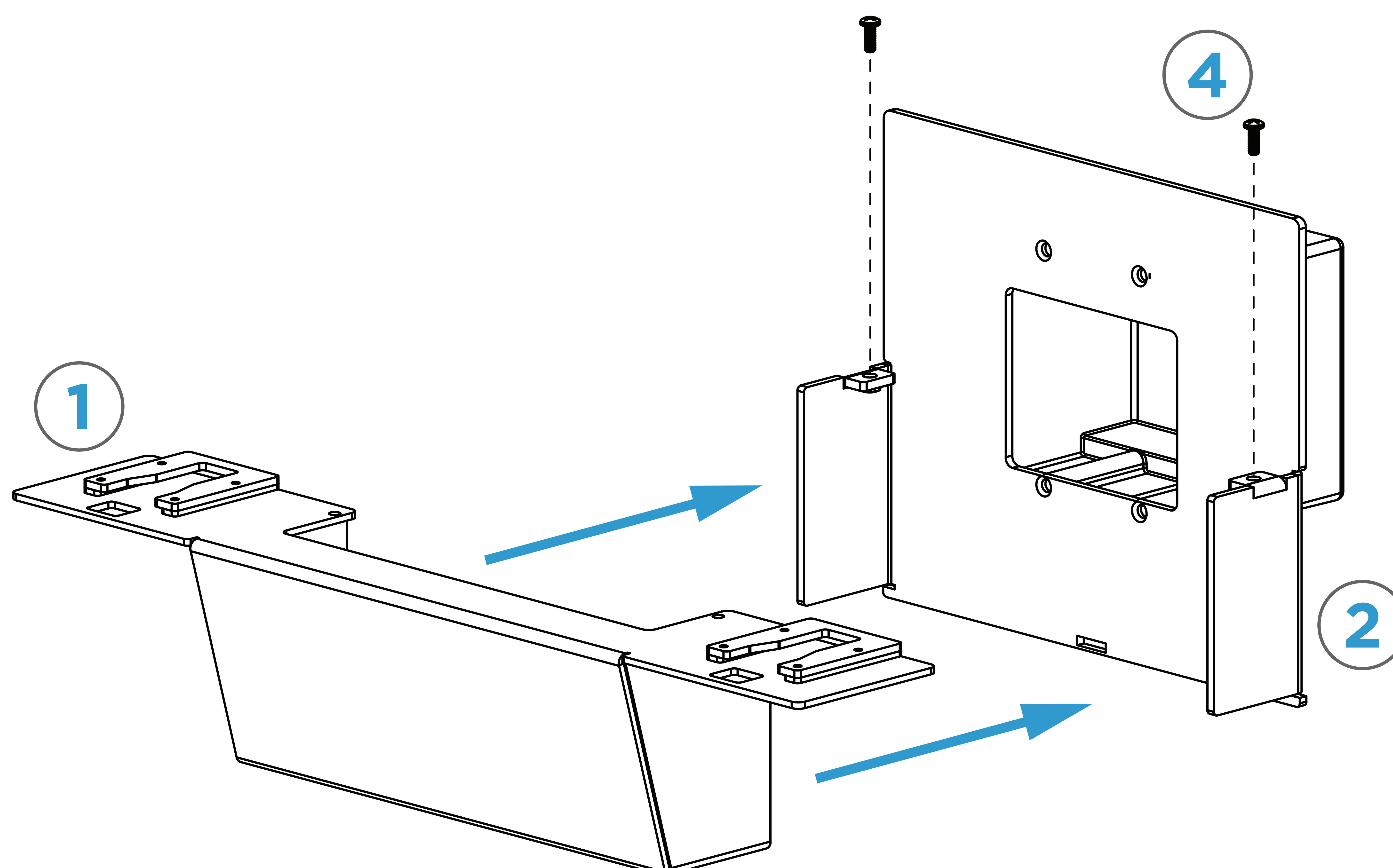

STEP 3: Attached Cisco QuadCam (No. 6, Qty 1) to Camera Plate.

